

de	Montageanleitung
en	Mounting instructions
fr	Instructions de montage
sv	Monteringsinstruktion
nl	Montage-aanwijzing
it	Istruzioni di montaggio
fi	Asennusohje
es	Instrucciones de montaje
da	Monteringsvejledning
pl	Instrukcja montażu
cz	Montážní návod
hu	Szerelési útmutató
tr	Montaj talimatları
el	Οδηγίες εγκατάστασης
ru	Инструкция по установке
zh	安装指导

Montagesatz
Mounting set
Kit de montage
Monteringsatts
Opbouwset
Accoppiamento
Asennussarja
Equipo de montaje
Monteringsæt
Zestaw montażowy
Montážní sada
Összeépítő készlet
Montaj seti
Μοχλισμός εγκατάστασης
Монтажный комплект
安装套件

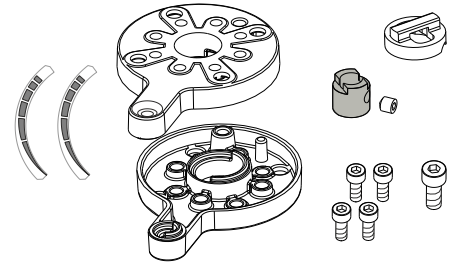

ASK31N

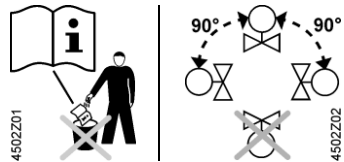

4502Z03



4502Z04

1...120 °C

VBF21..., DN 65...150
+
SAL..T10

<p>de Hinweise zur Montage Kompatibilität beachten. Die Konsole des Drehantriebs und Montagesatz dürfen nicht isoliert werden, um die Luftzirkulation zu gewährleisten.</p> <p>! Eine Berührung der erwärmten Teile ohne Schutzmassnahmen hat Verbrennungen zur Folge!</p>	<p>en Notes on mounting Observe compatibility. Do not insulate the actuator bracket and mounting set, as air circulation must be ensured!</p> <p>! Do not touch the hot parts without prior protective measures to avoid burns!</p>	<p>fr Indications pour le montage Respecter les indications de compatibilité. Ne pas calorifuger la console du servomoteur ni le kit de montage afin de permettre la circulation d'air!</p> <p>! Sans mesures de protection, tout contact avec des pièces chauffées peut entraîner des brûlures!</p>
<p>sv Montering Observera kompatibiliteten. Isolera inte styrventilhållaren och monteringsattsen eftersom luftcirkulationen måste säkerställas!</p> <p>! Beröring av uppvärmda delar utan skyddsåtgärder kan medföra brännskador!</p>	<p>nl Montageaanwijzing Let op compatibiliteit. Servomotor en montageset niet isoleren om voldoende luchtcirculatie te waarborgen!</p> <p>! Raak hete delen niet aan zonder bescherming om brandwonden te voorkomen!</p>	<p>it Note per il montaggio Rispettare la compatibilità Non isolare la staffa dell'attuatore e l'accoppiamento in modo da garantire la circolazione dell'aria.</p> <p>! Non toccare le parti calde senza misure di protezione preventiva al fine di evitare ustioni</p>
<p>fi Huomioitavaa asennuksessa Huomioi yhteensopivuus. Älä eristä toimilaitteen jalkaa eikä asennussarjaa ilman saannin varmistamiseksi! ! Älä koske kuumiin osiin ilman sopivia suojavälineitä, palovamman riski!</p>	<p>es Notas sobre el montaje Observe compatibilidad. No aislar el soporte del actuador y juego de montaje, la circulación de aire debe estar garantizada</p> <p>! No toque las partes calientes sin las medidas previas de protección para evitar quemaduras!</p>	<p>da Bemærkninger til montering Tag hensyn til kompatibiliteten. Motorkonsol og monteringsæt må ikke dækkes af isolering, da der skal være luftcirkulation!</p> <p>! Rør ikke ved de varme dele uden beskyttelse, da man ellers vil blive forbrændt!</p>
<p>pl Uwagi dotyczące montażu Przestrzegać kompatybilności. Nie izolować uchwyty siłownika i zestawu montażowego w celu zapewnienia cyrkulacji powietrza! ! Nie wolno dotykać gorących elementów bez wcześniejszego zastosowania środków ochrony, w celu uniknięcia oparzeń!</p>	<p>cz Poznámky k montáži Dodržujte kompatibilitu. Neizolujte konzolu pohonu a montážní sadu, protože musí být zajištěna cirkulace vzduchu! ! Nedotýkejte se horkých částí bez ochranných opatření, aby nedošlo k popálení!</p>	<p>hu Szerelési utasítás Ügyeljen a kompatibilitásra. Ne szigetelje le a mozgató motor konzolját és a szerelő készletet, hogy a légáramlás biztosítva legyen! ! Ne érintse meg a forró alkatrészeket, mielőtt égési sérülések elleni intézkedéseket nem tett!</p>
<p>tr Montaj notları Uyumluluğa dikkat edin. Aktüatör braketini ve montaj setini izole etmeyin. Brakette ve vana milinde hava akışı sağlanmalıdır. ! Yanık riskini önlemek için, koruma önlemleri almadan sıcak parçalara dokunmayın.</p>	<p>el Οδηγίες εγκατάστασης Προσοχή στη συμβατότητα. Μην μονώσετε το σώμα του κινητήρα και το σετ τοποθέτησης, ο κινητήρας πρέπει να αερίζεται! ! Νε прикасайтесь руками к нагревающимся частям!</p>	<p>ru Замечания по монтажу Учитывайте совместимость. Не изолируйте крепление привода и монтажный комплект, поскольку необходимо обеспечить циркуляцию воздуха! ! 如果未预先采取保护措施, 禁止触摸加热部件, 以防止烫伤!</p>

zh 安装说明

请遵守设备组合中的配套使用规定。

禁止对执行器及支架保温，须保证空气流动。

⚠ 如果未预先采取保护措施，禁止触摸加热部件，以防止烫伤！

A 4 mm

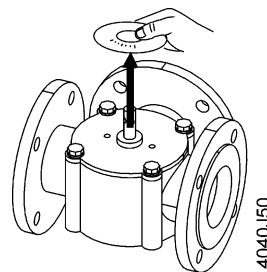
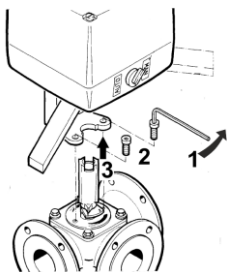

B

de	Kesselvorlauf von links	en	Boiler flow from left	fr	Départ chaudière à gauche
sv	Pannans framledningsvatten från vänster	nl	Keteltoevoer van links	it	Caldaia a sinistra
fi	Vesisäiliön menovesi vasemmalta	es	Flujo de caldera desde la izquierda	da	Kedelfremløb fra venstre
pl	Zasilenie kotła z lewej	cz	Přívod z kotle zleva	hu	Kazán oldali előremenő balról
tr	Soldan kazan akışı	el	Προσαγωγή λέβητα από αριστερά	ru	Поток из котла поступает с левой стороны
zh	锅炉水从左流入				

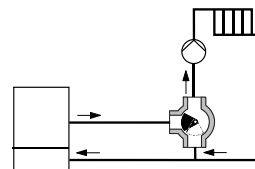
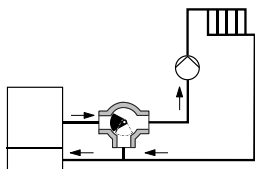

B1 SAL31.. SAL81.. SAL6..1 ➔ AZX61.1 (A6V10321407)

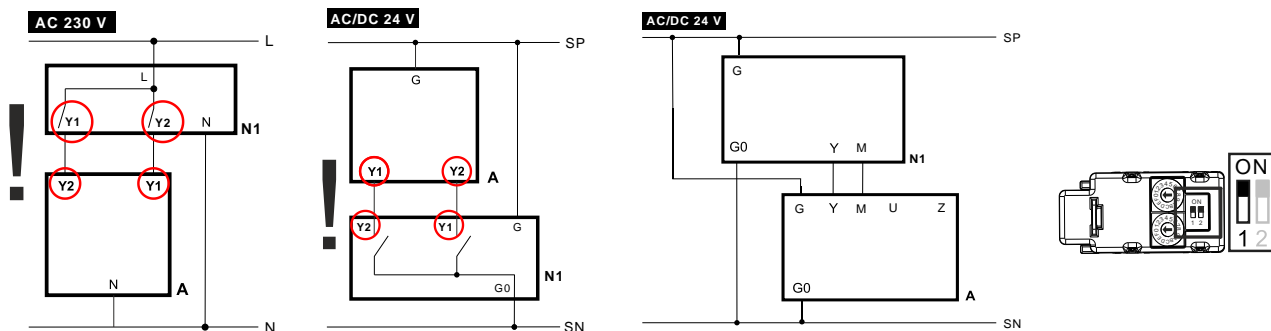

B2

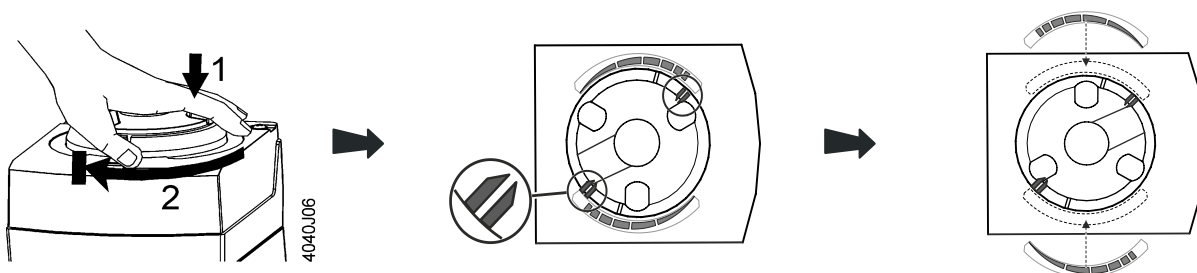

B3a



4 mm, 5 mm



12 mm



5...7 Nm

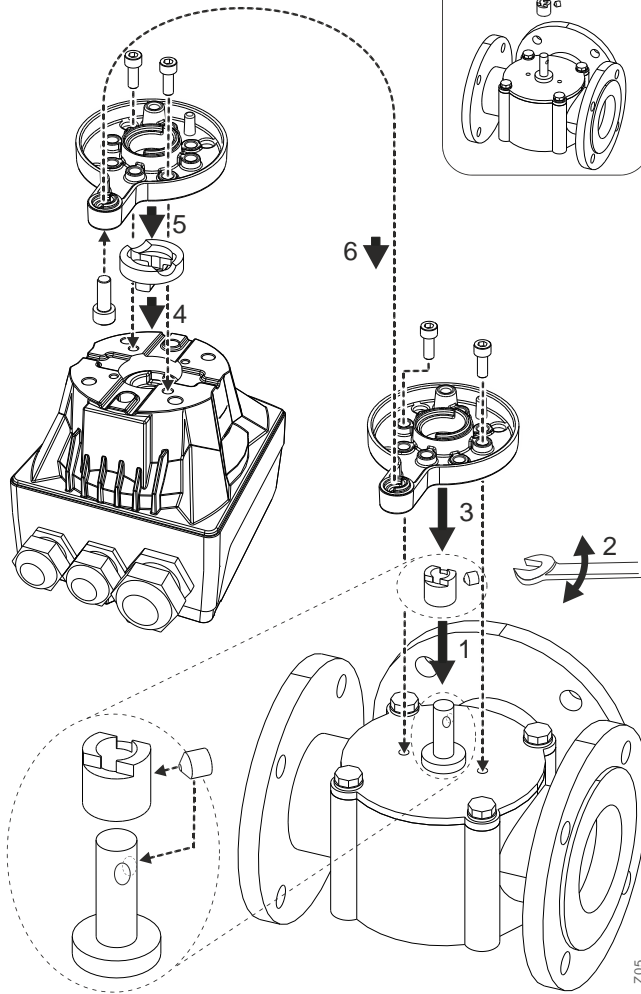
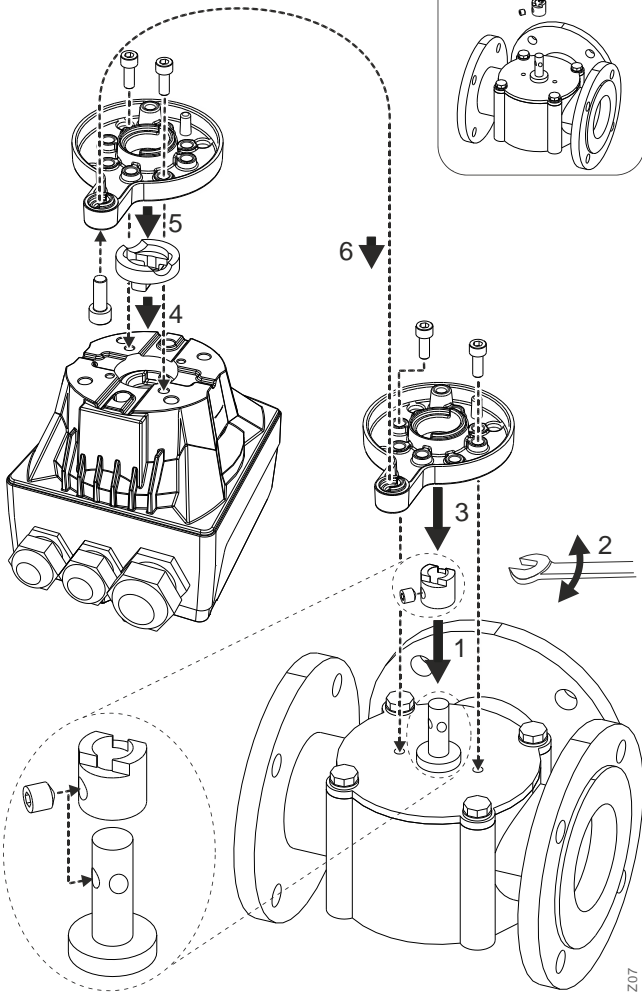
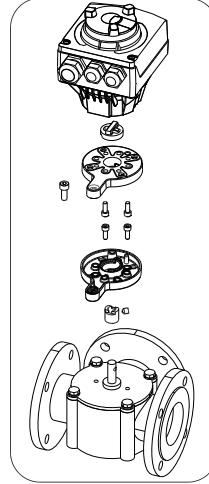
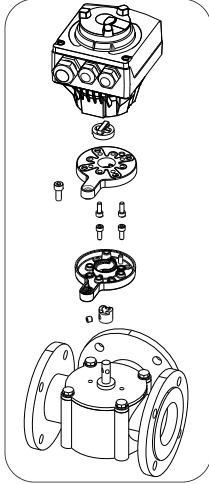
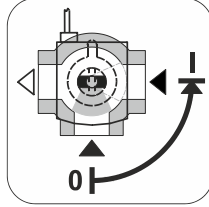
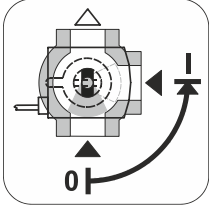
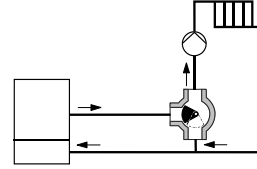
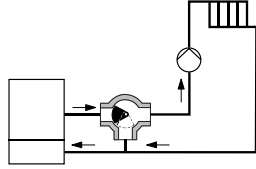

B3b

4 mm, 5 mm

12 mm

5...7 Nm

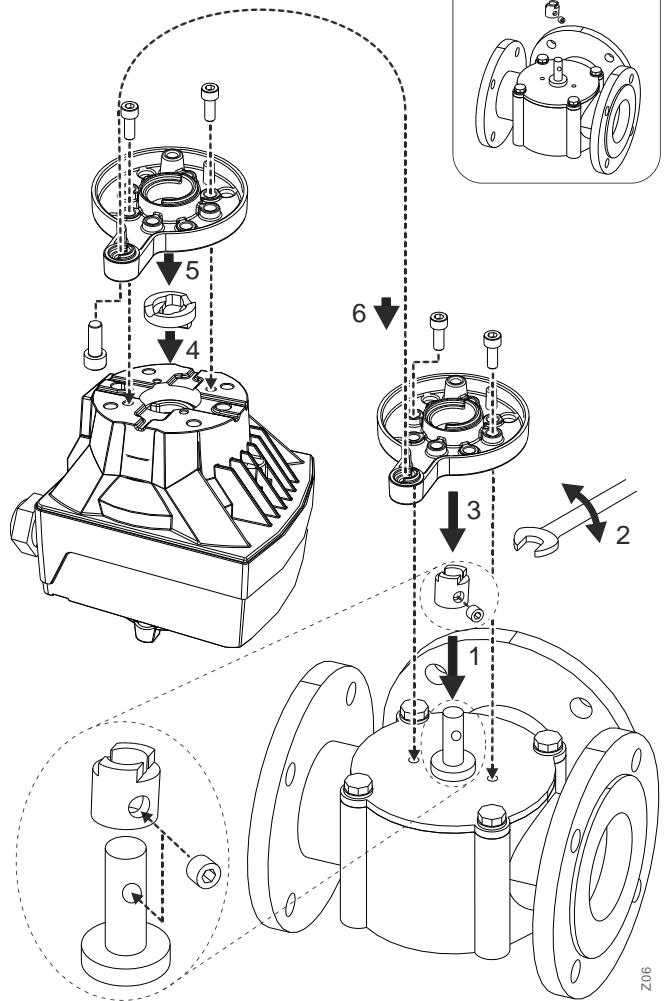
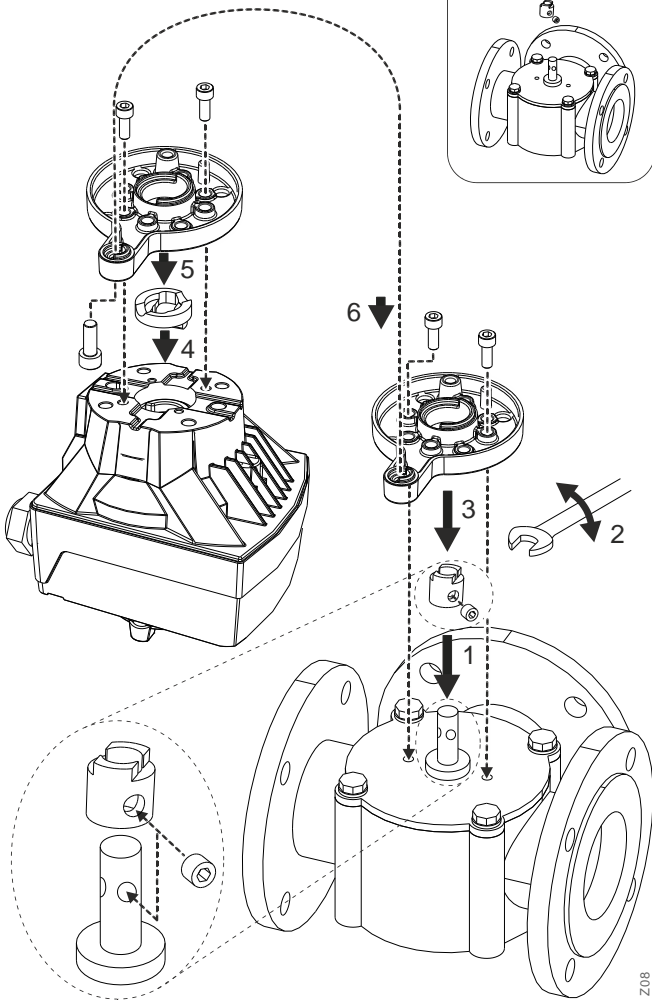
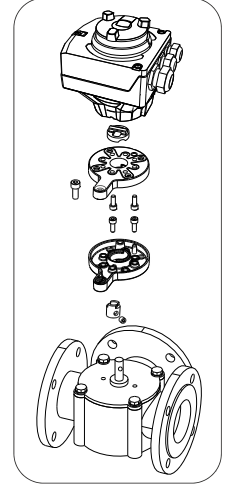
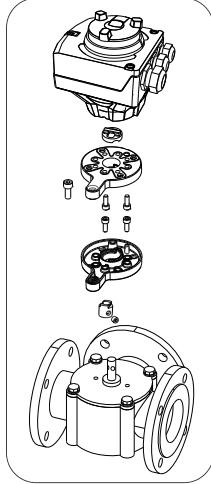
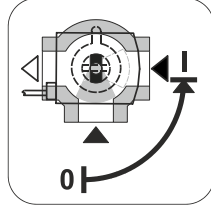
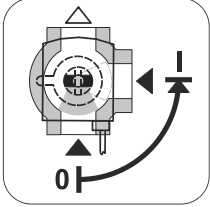
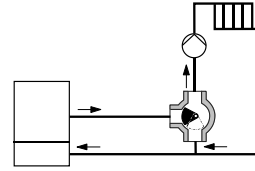
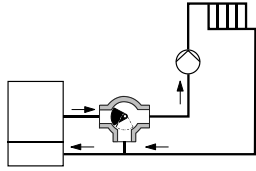

C

de	Kesselvorlauf von rechts	en	Boiler flow from right	fr	Départ chaudière à droite
sv	Pannans framledningsvatten från höger	nl	Keteltoevoer van rechts	it	Caldaia a destra
fi	Vesisäiliön menovesi oikealta	es	Flujo de caldera desde la derecha	da	Kedelfremløb fra højre
pl	Zasilenie kotła z prawej	cz	Přívod z kotle zprava	hu	Kazán oldali előremenő jobbról
tr	Sağdan kazan akışı	el	Προσαγωγή λέβητα από δεξιά	ru	Поток из котла поступает с правой стороны
zh	锅炉水从右流入				

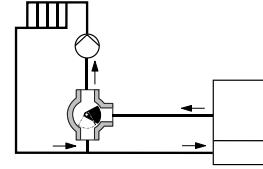
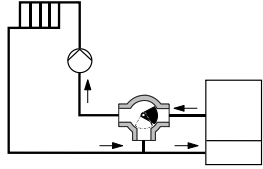

C1

SAL31

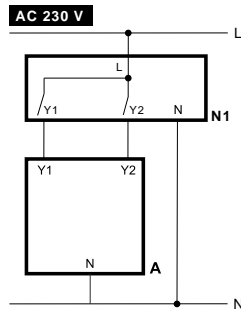

SAL81

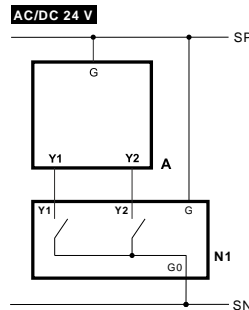

SAL61

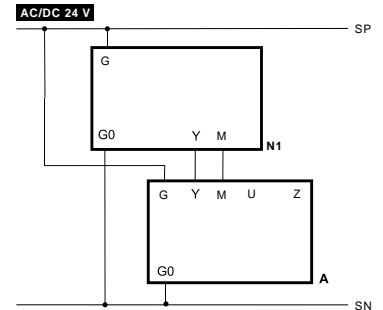

C2

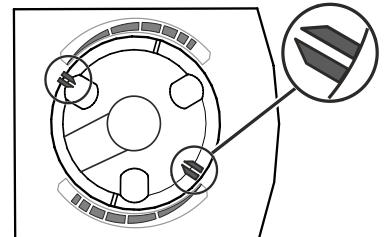
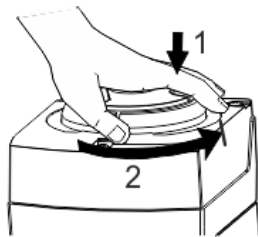

C3a

4 mm, 5 mm

12 mm

5...7 Nm

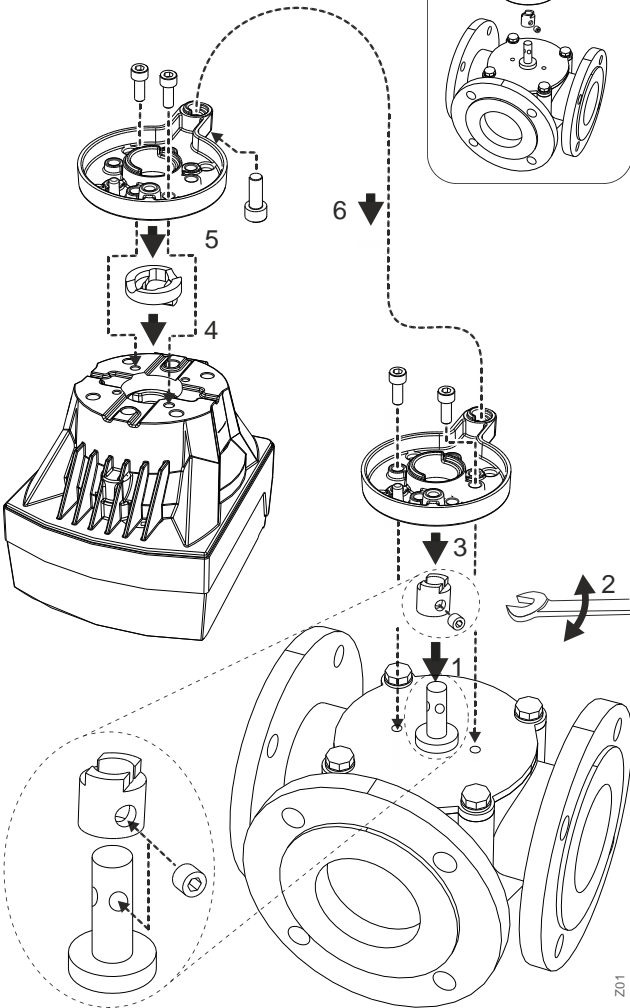
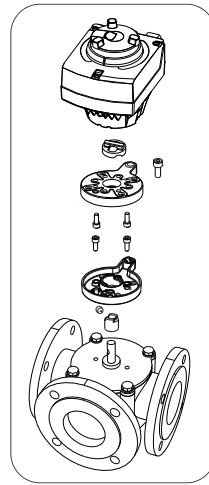
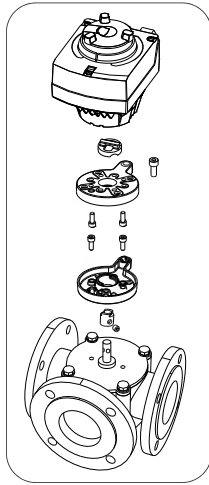
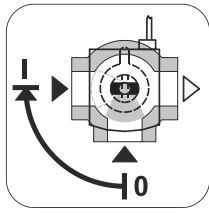
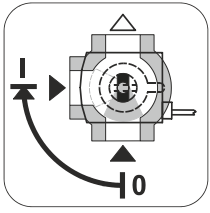
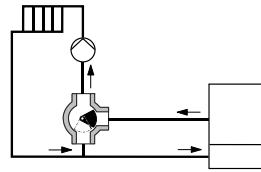
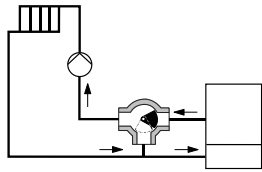

Z01

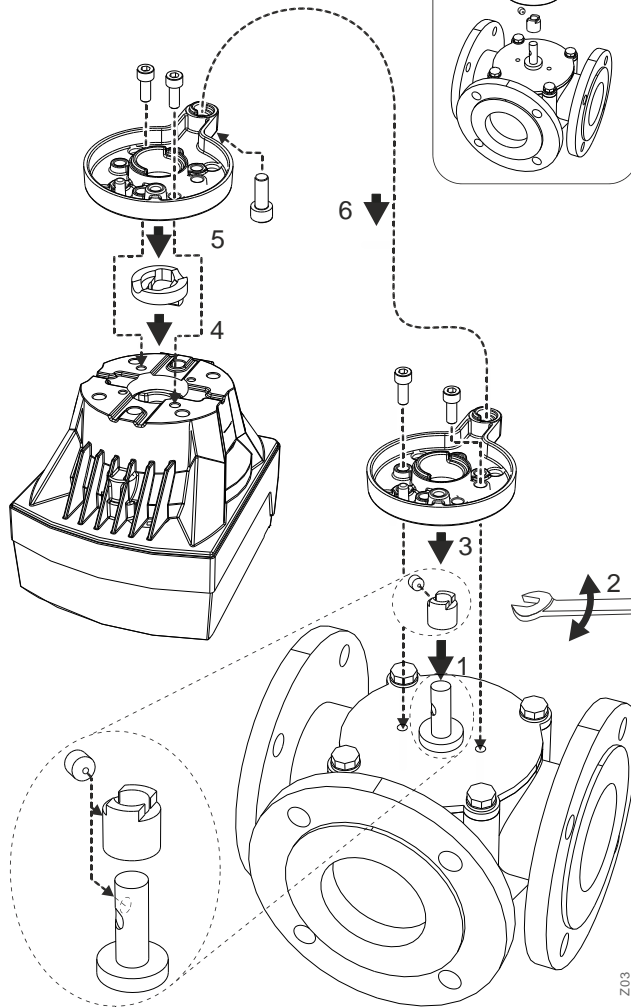

Z03

C3b

4 mm, 5 mm

12 mm

5...7 Nm

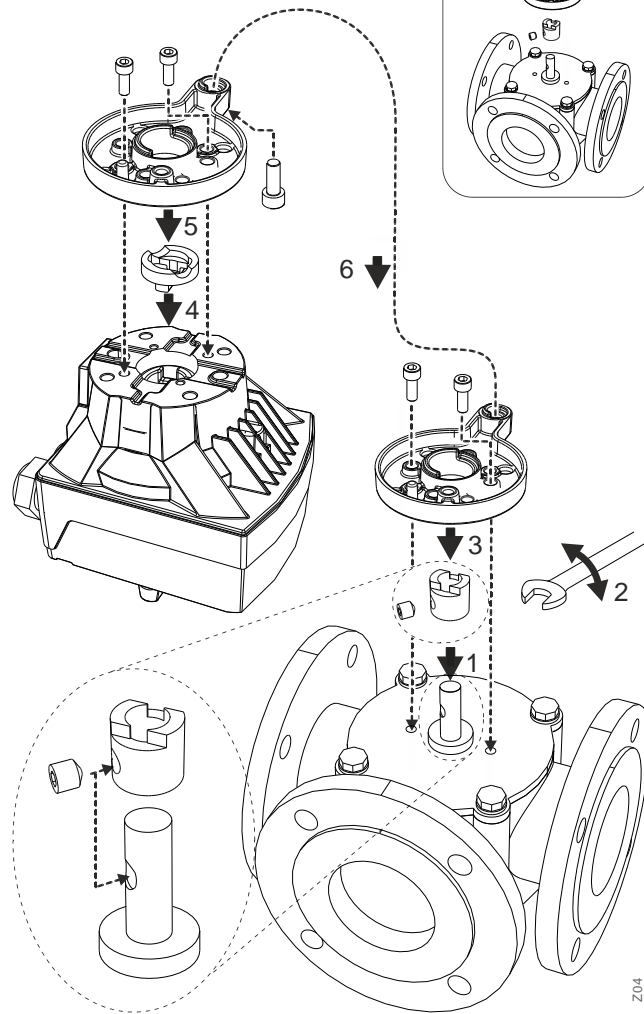
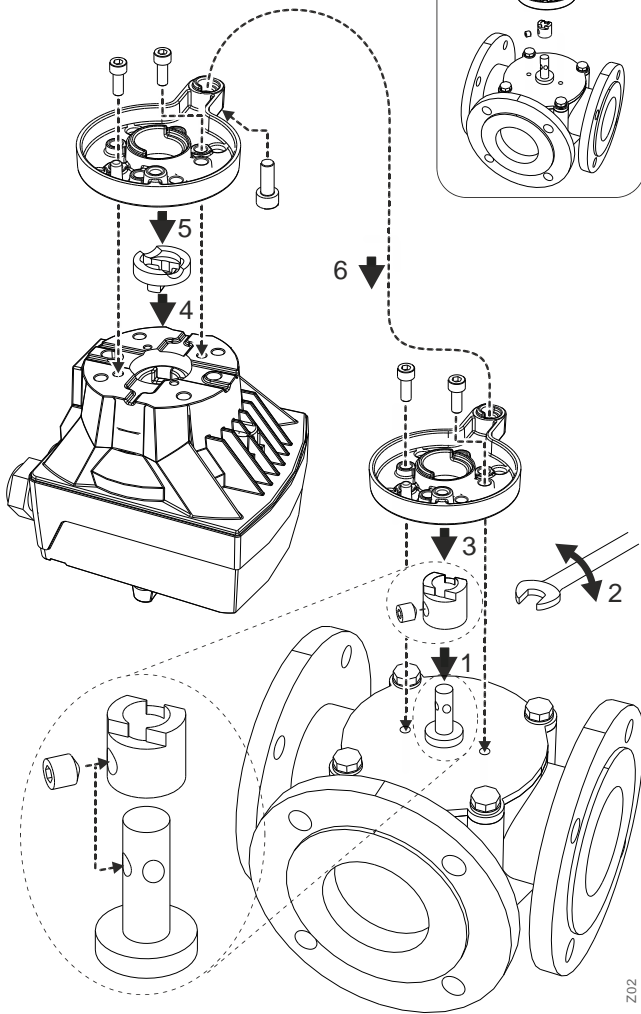
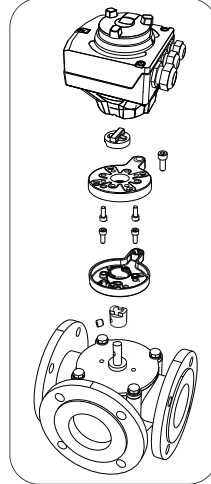
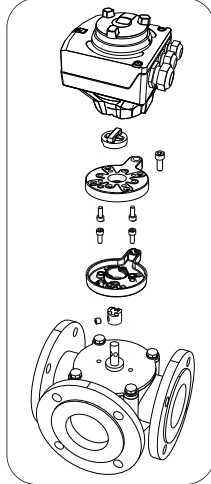
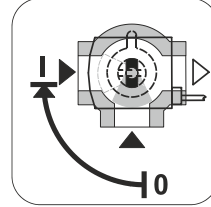
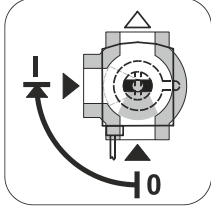
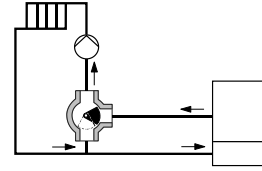
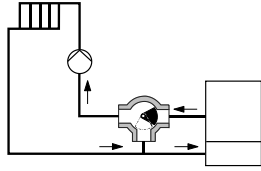

de	Hinweise zur Montage Für weitere Montagelagen und Wegführung der Anschlusskabel installieren Sie den Drehantrieb und Montagesatz entsprechend den obenstehenden Darstellungen.	en	Notes on mounting For other mounting positions and cable outlet directions install the rotary actuator and mounting set analogously as per above illustrations.	fr	Indications pour le montage Pour d'autres positions de montage et sorties du câble de raccordement, installer le servomoteur rotatif et le kit de montage conformément aux illustrations précédentes.
sv	Montering För övriga monteringslägen och kabelutgångsriktningar skall det vridande ställdonet och monteringssetsen installeras enligt illustrationer ovan.	nl	Montageaanwijzing Voor verschillende montageposities en kabelinvoer richtingen kan de servomotor met de montageset volgens de illustraties worden gemonteerd.	it	Note per il montaggio Per altre posizioni di montaggio e direzioni di uscita dei cavi installare l'attuatore rotativo e l'accoppiamento secondo i disegni sopra riportati.
fi	Huomioitavaa asennuksessa Toimilaitteen toisten asennusasetojen ja kaapelien ulostulojen takia, asenna aina karälämmitin yllä olevien kuvien mukaan.	es	Notas sobre el montaje Para otras posiciones de montaje y la instalación del cable de conexión usar el kit de montaje del actuador según las representaciones anteriores.	da	Bemærkninger til montering Ved andre monteringspositioner og retninger for tilslutningskabler installerer drejemotoren og beslagene i overensstemmelse med ovenstående illustrationer.
pl	Uwagi dotyczące montażu W przypadku innych pozycji montażowych i kierunków wyprowadzeń przewodów należy montować silownik obrotowy i zestaw montażowy zgodnie z powyższymi rysunkami.	cz	Poznámky k montáži Pro ostatní montážní polohy a směry výstupu kabelu instalujte rotační pohon a montážní sadu analogicky podle ilustrací zobrazených výše.	hu	Szerelési utasítás Más szerelési helyzet és csatlakozó kábel kivezetési irányú esetén a fenti ábráknak megfelelően installálja a forgatómotort.
tr	Montaj notları Diğer montaj konuları ve kablo çıkış yönleri için döner aktüatörü ve montaj setini yukarıdaki çizimlere benzer şekilde monte edin.	el	Οδηγίες εγκατάστασης Για άλλες θέσεις τοποθέτησης και καλωδίωσης εγκαταστήστε τον περιστροφικό κινητήρα και το σετ τοποθέτησης σύμφωνα με τις παραπάνω εικόνες.	ru	Замечания по монтажу Для других положений установки и направления кабельных вводов устанавливайте поворотный привод аналогично тем рисункам, которые были приведены ранее.
zh	安装说明 对于角行程执行器其他位置的安装及接线与上述方法类似。				